

Portfolio

Nathan Garion
2025 / 1st - 3rd Y

Interior Architecture
& Product Design

Le Lab

Architecture - Renovation of a building in the new neighborhood of St-Vincent de Paul

3

Split

Product design - Lamp

7

Ionox

Micro-architecture / Design - Urban furniture

9

Calcestruzzo

Architecture - Villa Medici's bedrooms renovation

11

Riom168

Architecture - Rehabilitation of an WWII prison into a youth hostel

13

Exo

Service and Product Design - Connected object concept

15

IceBerg

Product design - Vodka bottle

18

Trip to Mars

Product design - Toy

20

Selva

Architecture - Brazilian villa concept

21

Le Lab - 2024

Architecture - Renovation of a building in the new neighborhood of St-Vincent de Paul

Le Lab is a café / hackerspace located in one of the buildings of the new St Vincent de Paul neighborhood. It's sole objective is to include this new "city in the city" in our contemporary era in which technology is everywhere. Le Lab would be a multifunctional place that aims to connect the people between them and towards the world.

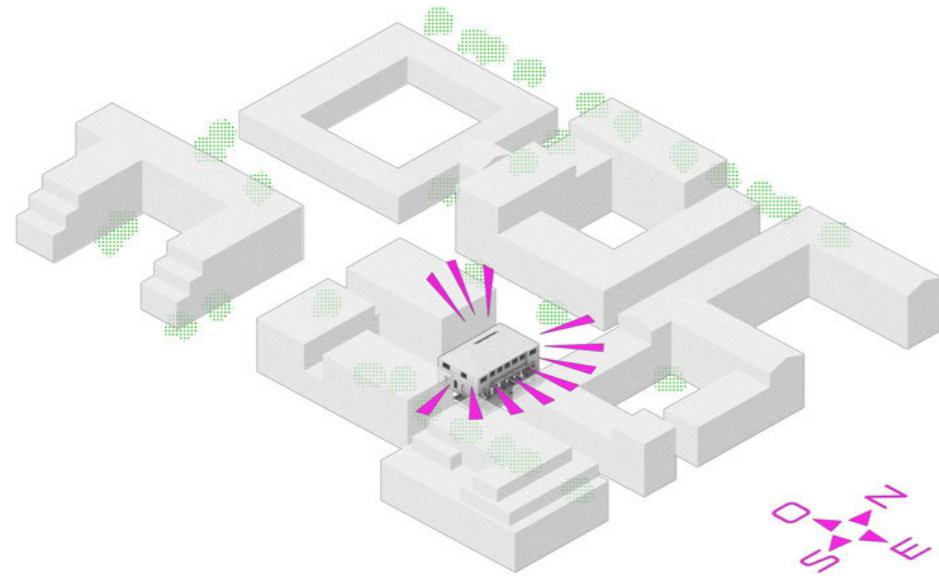

- Hackerspace's library

- Bleachers



- Hackerspace's electronics lab

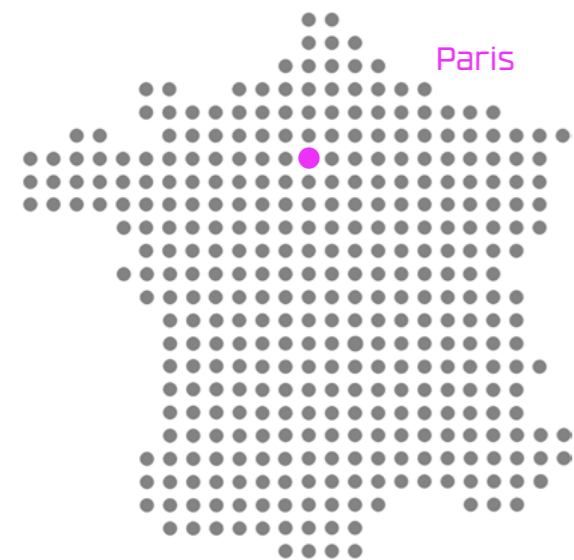

Le Lab

Projects's isometrics

- ① Elevator access
- ② WC
- ③ Principale zone
- ④ Calm space and conference room
- ⑤ Bleachers and entries of light
- ⑥ Bar
- ⑦ Kitchen
- ⑧ Storage

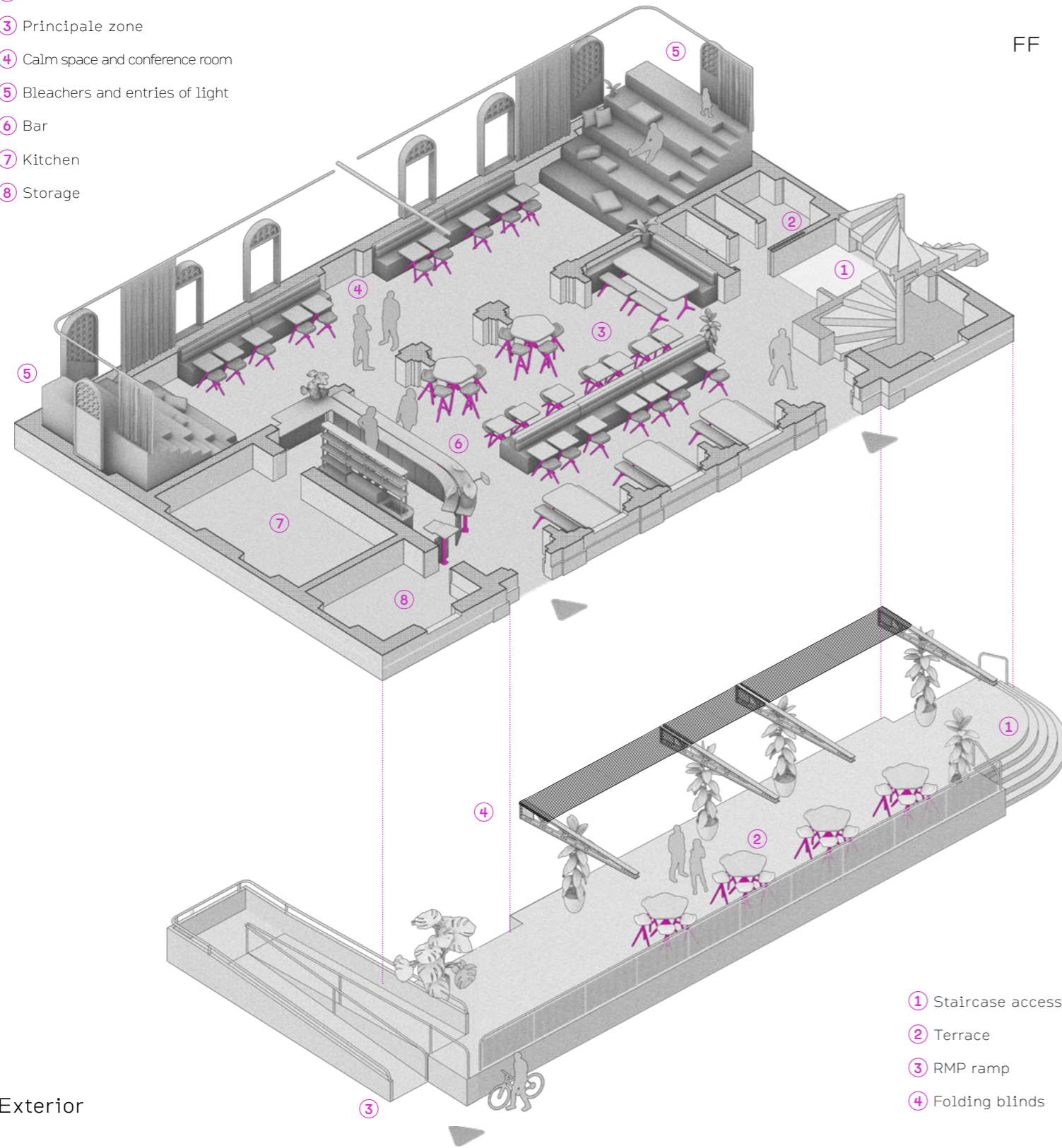

Exterior

FF

R+1

↔ Translucent partitions and textile sound insulation - movable

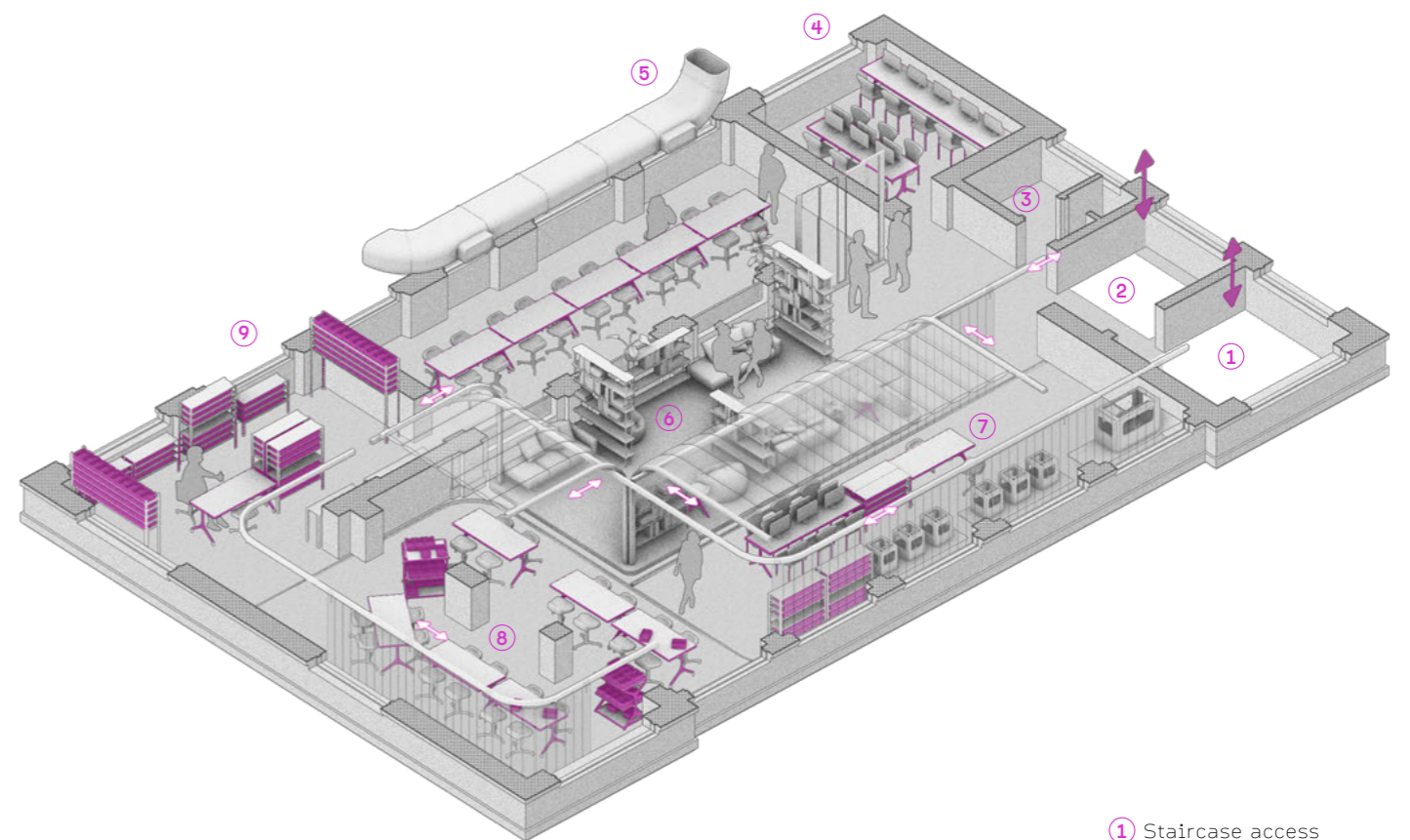

- ① Staircase access
- ② Elevator access
- ③ WC
- ④ Computer room
- ⑤ Electronic Lab
- ⑥ Library space
- ⑦ Machine room / Fab Lab
- ⑧ Modular classrooms
- ⑨ Storage room

Le Lab - 2024

Project's plans and details

Floor plans scale :

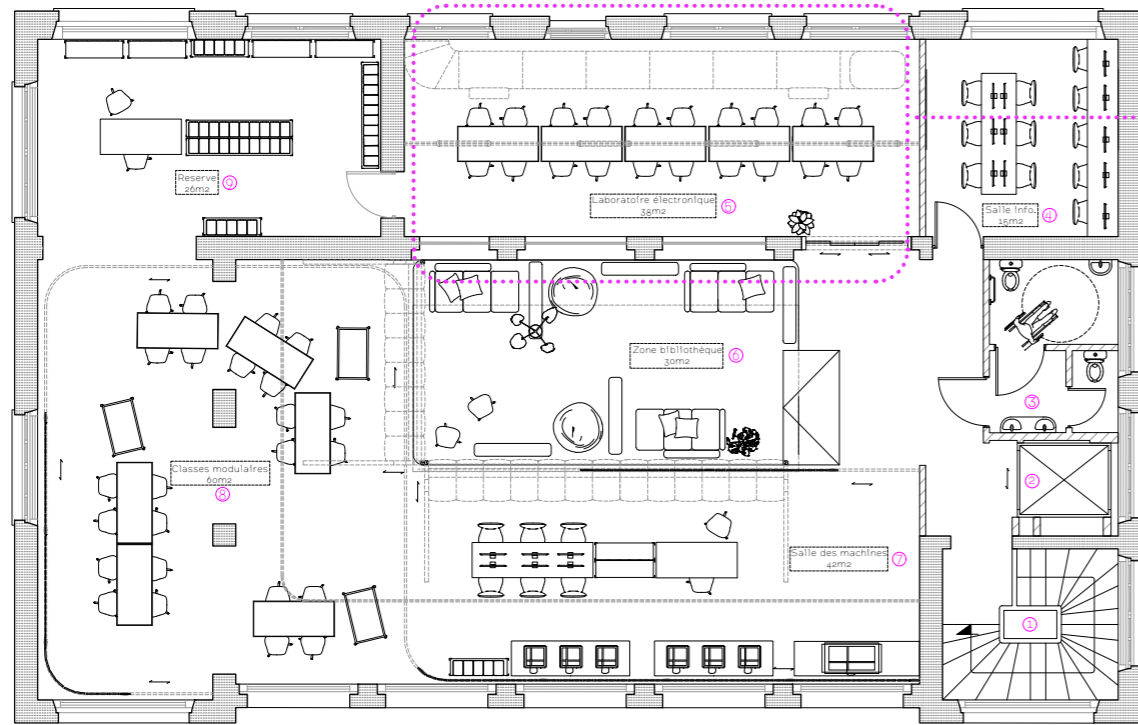
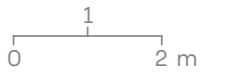

R+1

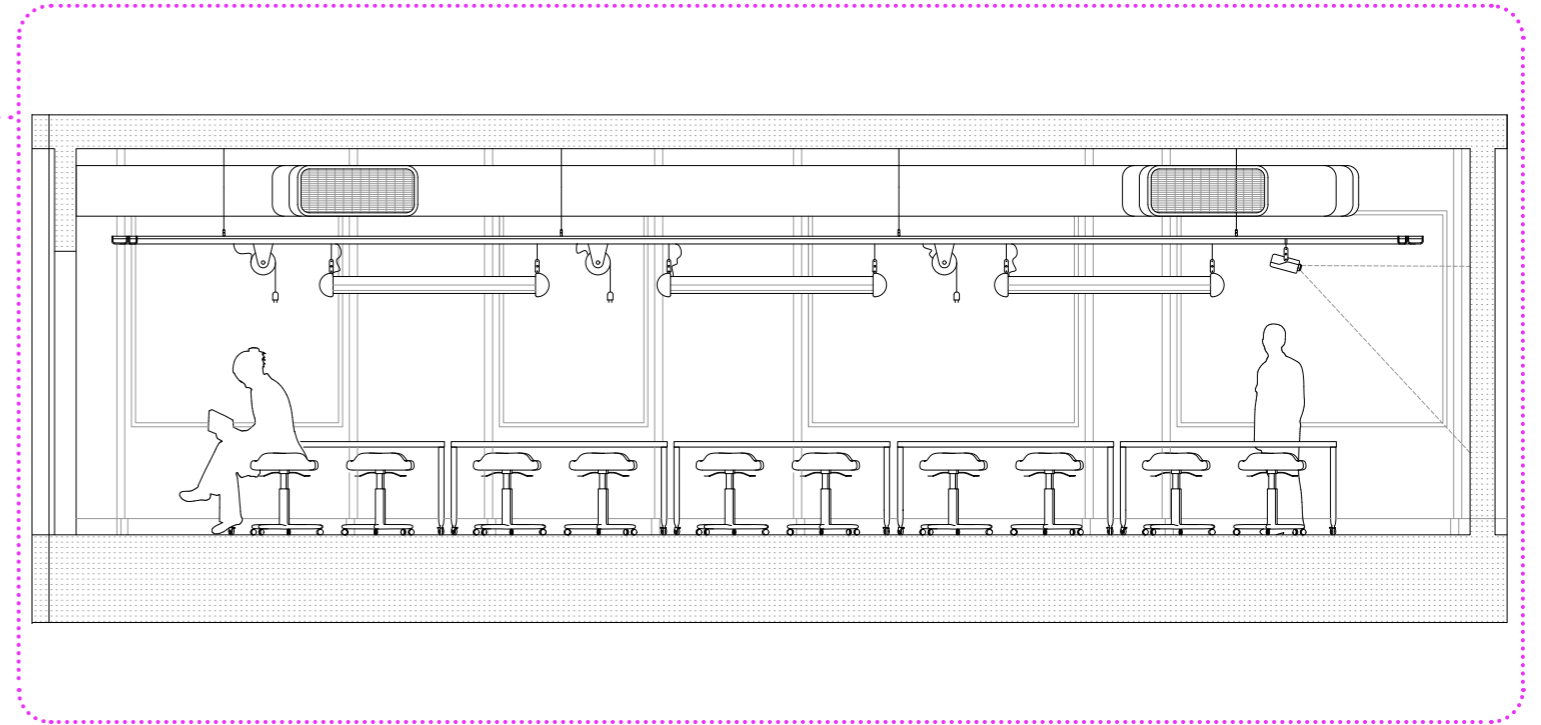

- Electronics Lab section

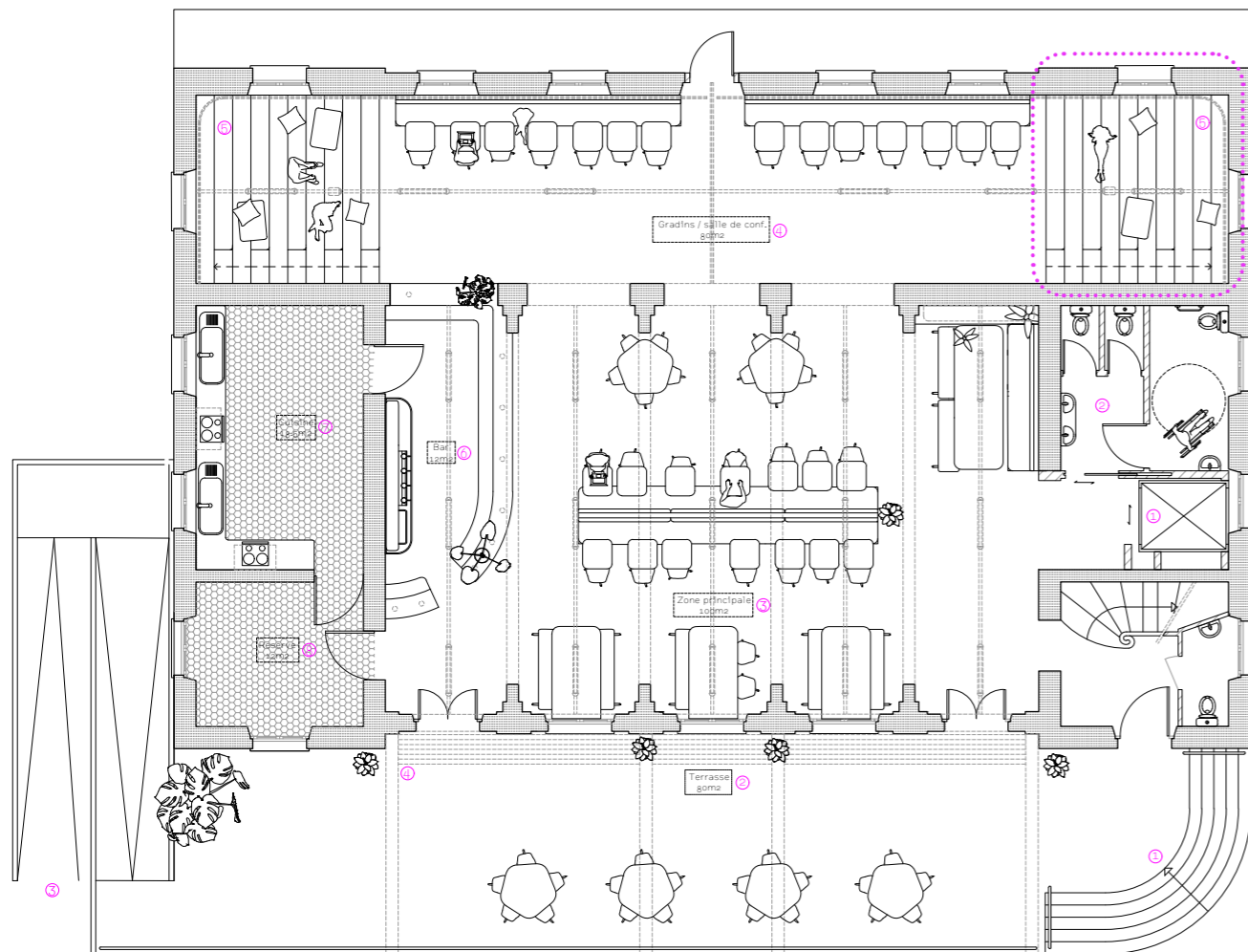

FF

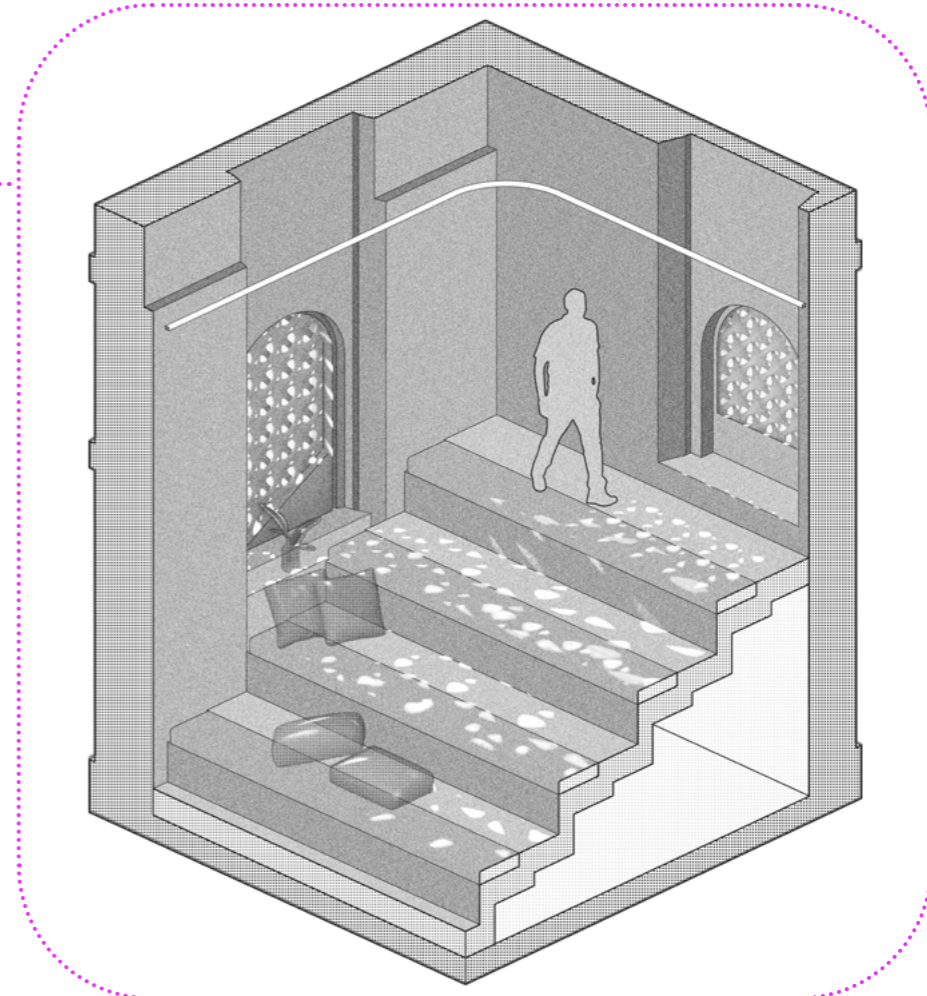

- Bleachers light treatment study using simulations

Le Lab

Sections and project's situation

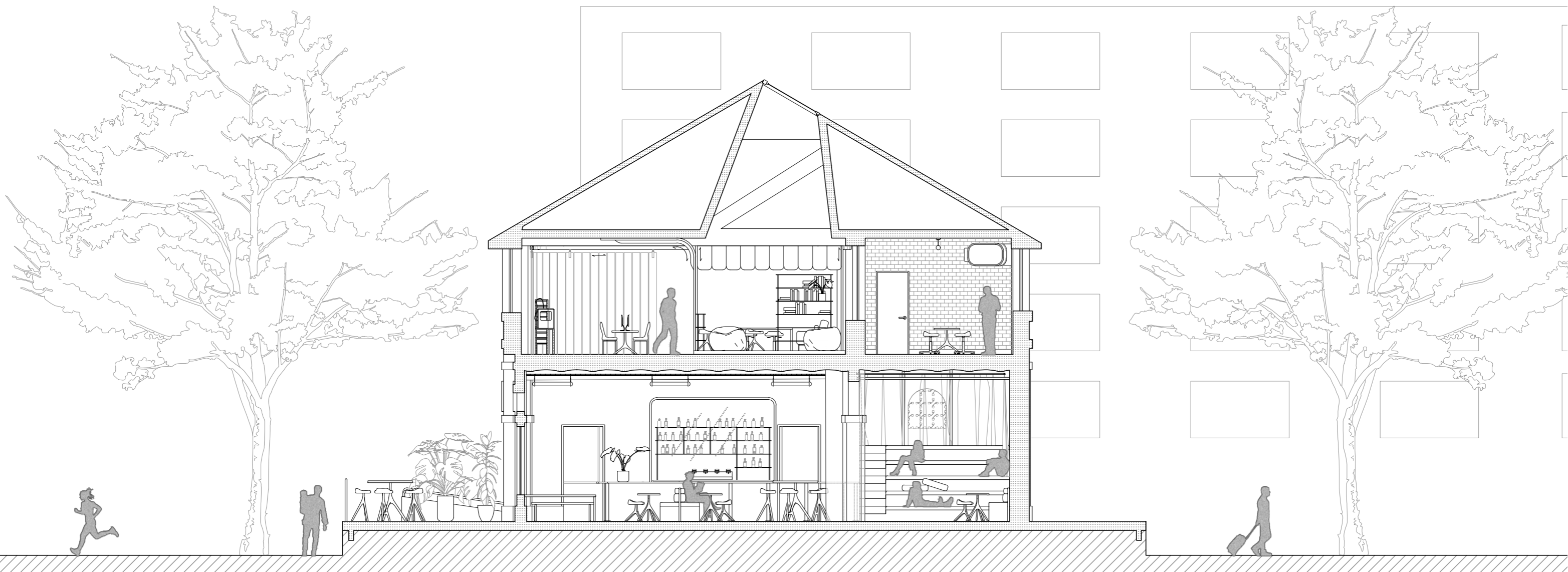
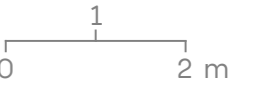

Split - 2024

Product design - Lamp

Split is a lamp that comes from shape researches and experiments around pipes. It's structure is made out of two precisely bent aluminum tubes that fit together using magnets thus making it possible to "break" or "split" the lamp. The objectives were to obtain a flat-packed elegant and simple looking object out of very complex processes.

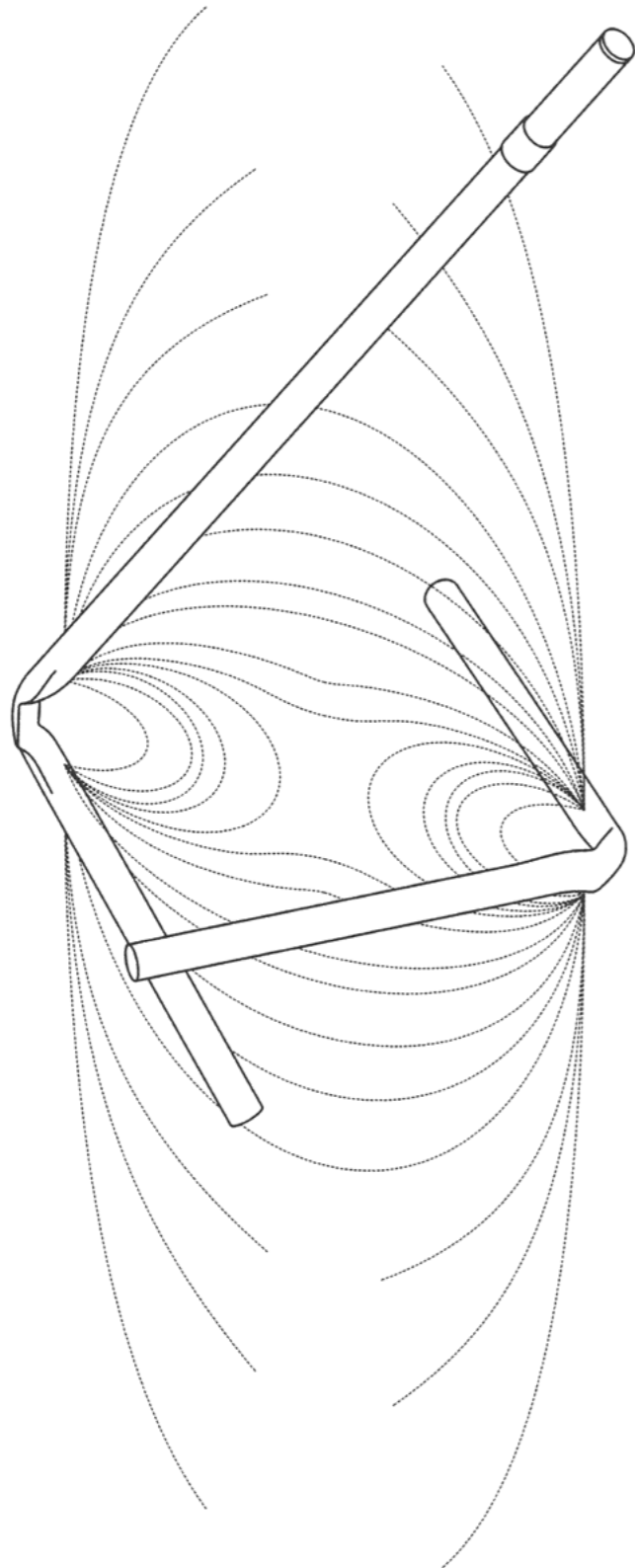

split

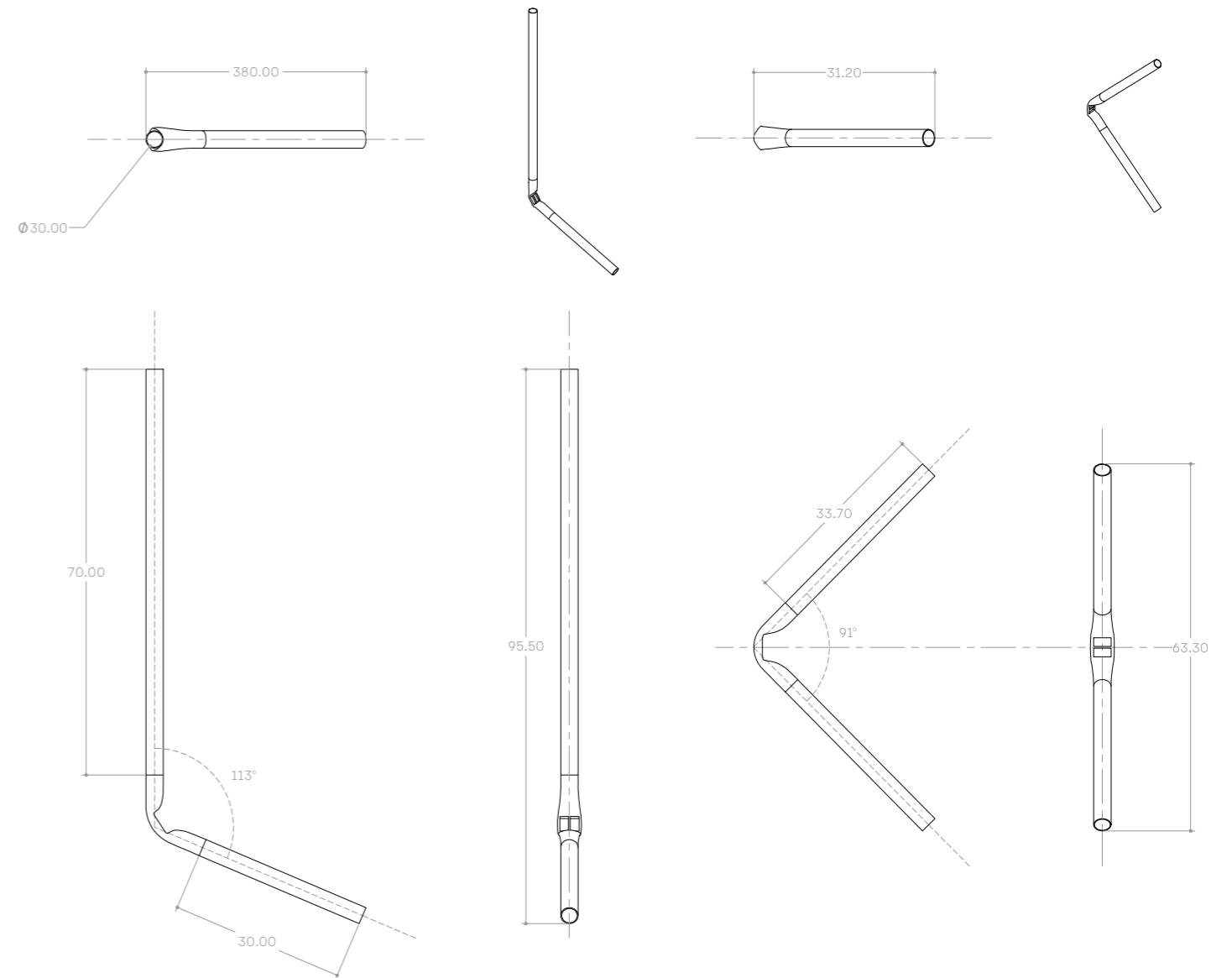

- Technical plans of the two tubes

Split Visuals

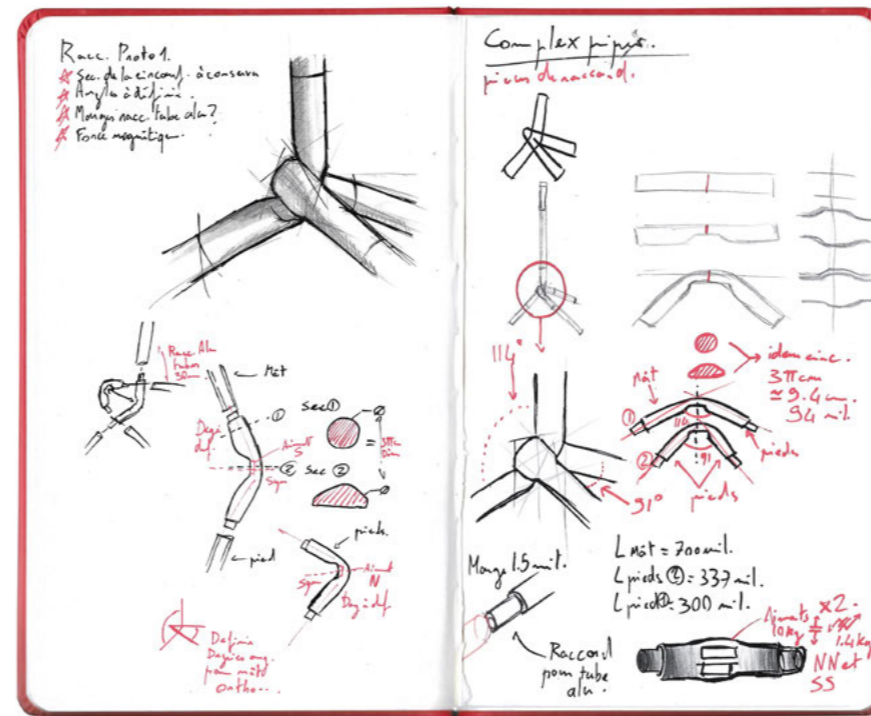
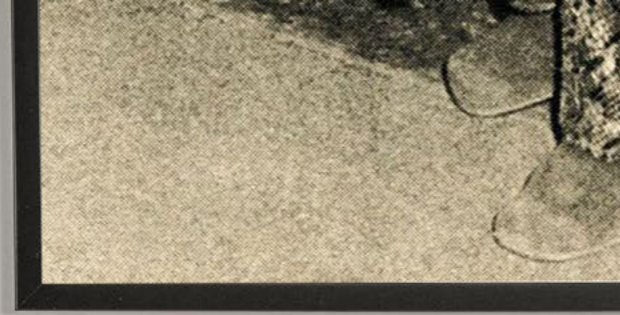

- Researches, sketches and prototyping

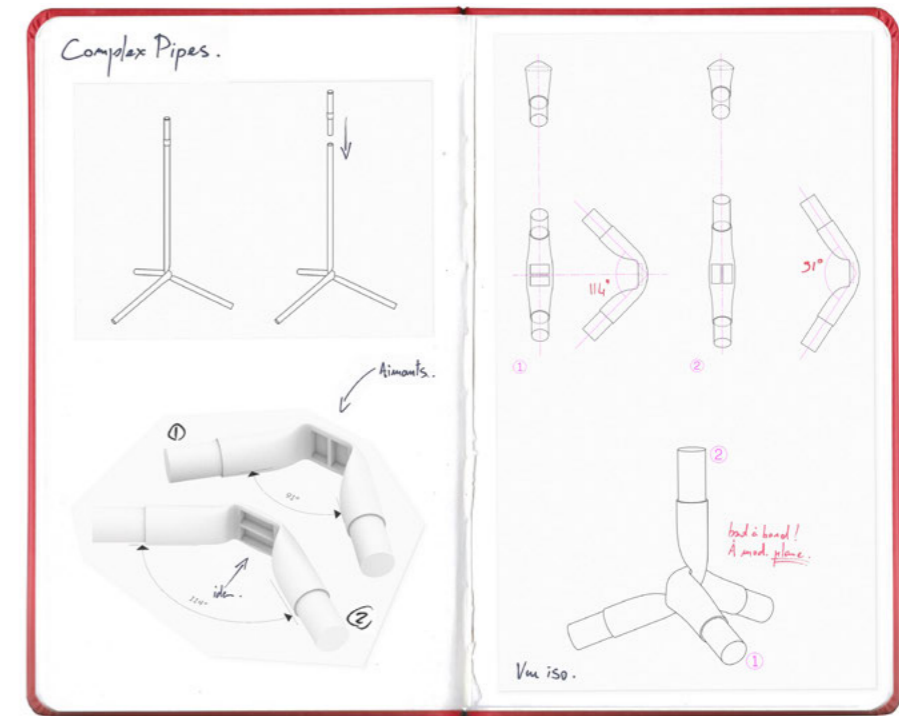

- First functional prototype in the workshop



- Rechargeable head lamp part

- Fully split view

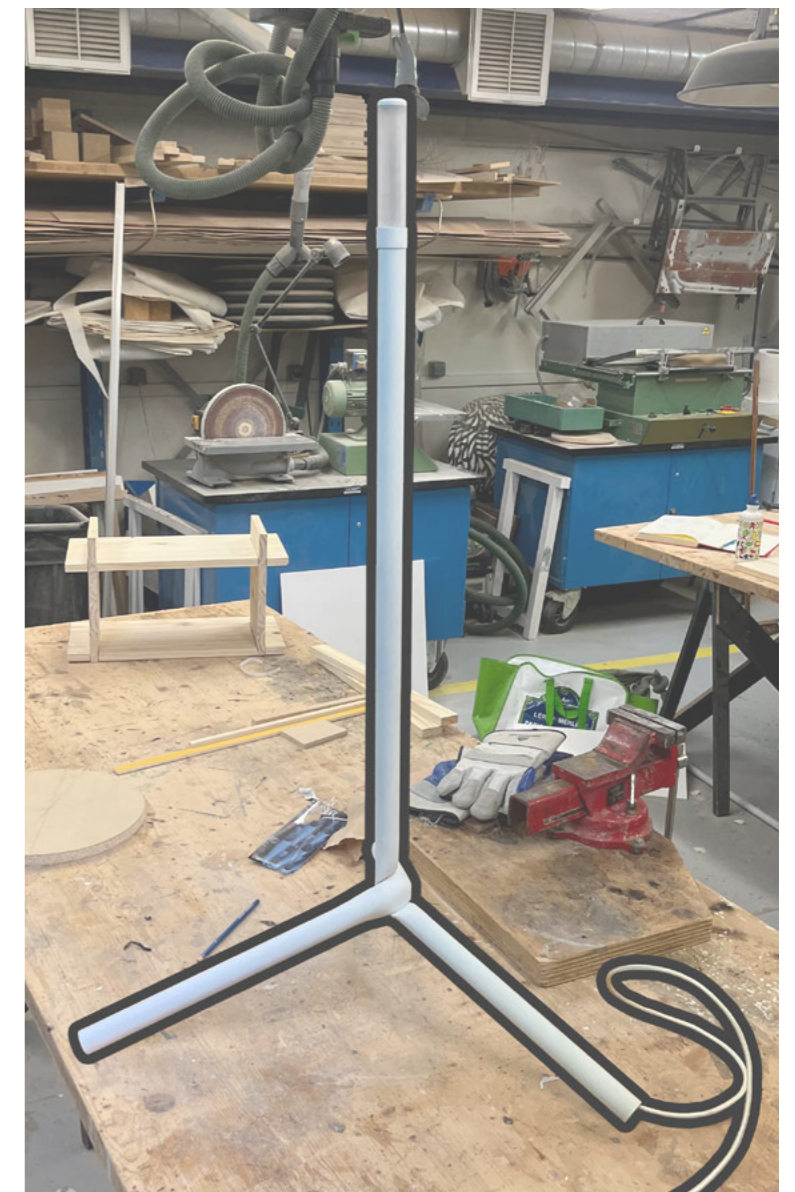
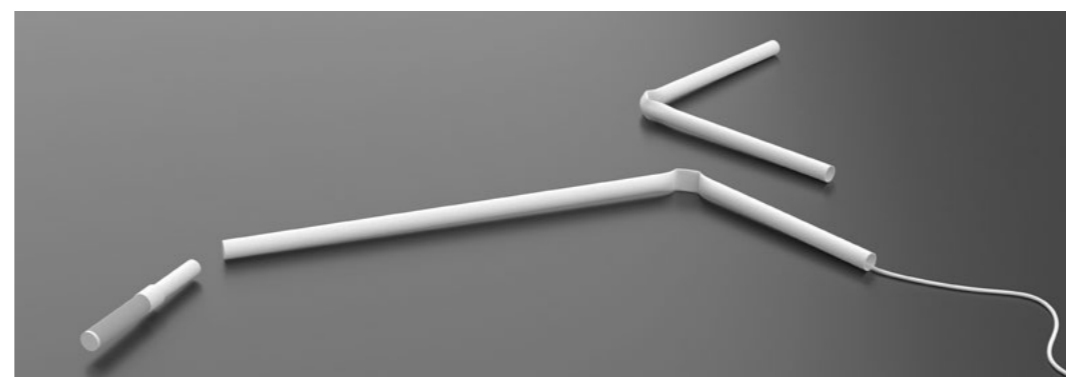

Ionox - 2023

Micro-architecture / Design - Urban furniture

Ionox est un abri modulaire multifonctionnel. Inspiré par la géométrie du pentagone, Ionox a pour objectif de lier les esthétiques moderne et de l'Art Nouveau puisqu'il est supposé s'implanter près des stations de métro parisiennes.

IONOX



IONOX

Project's situation and technicity

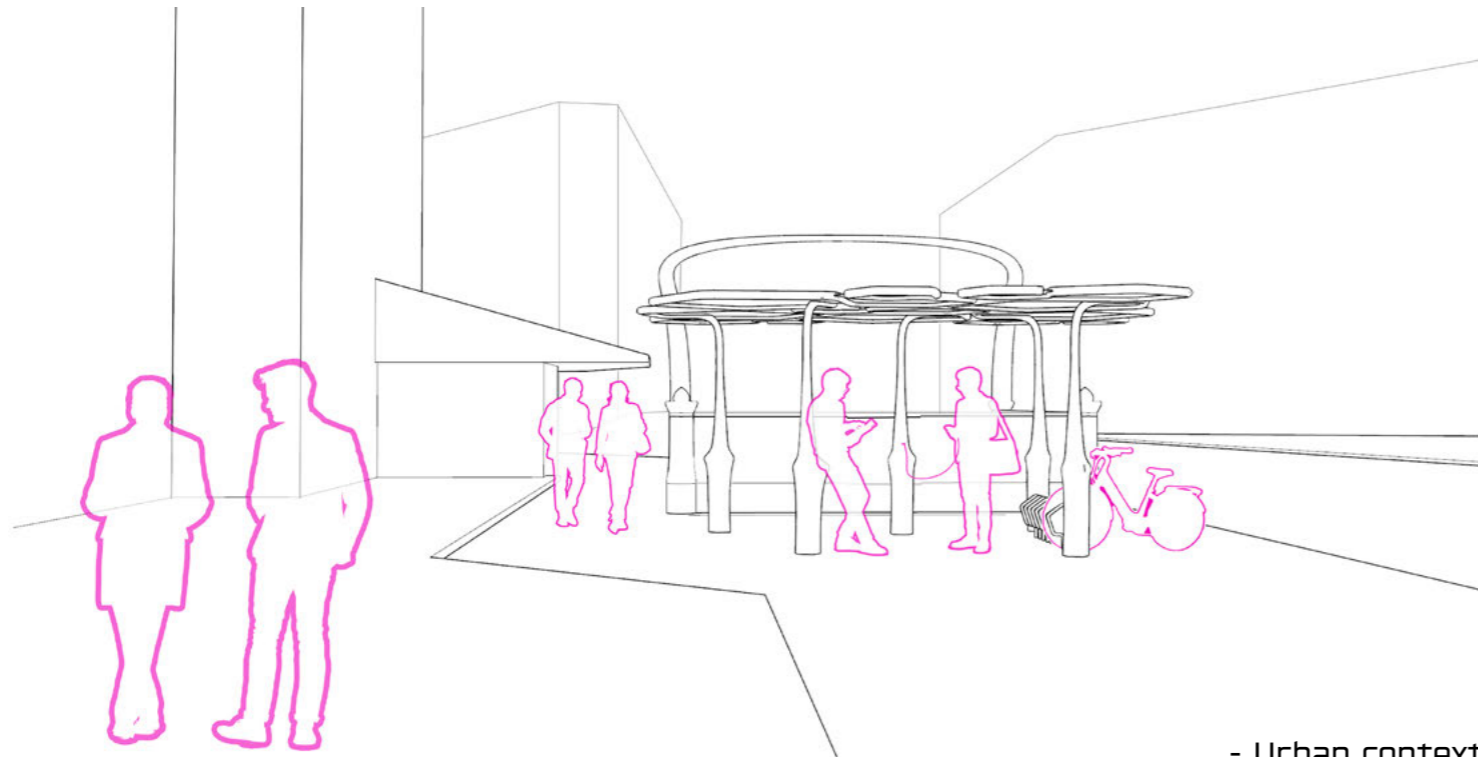

- Urban context

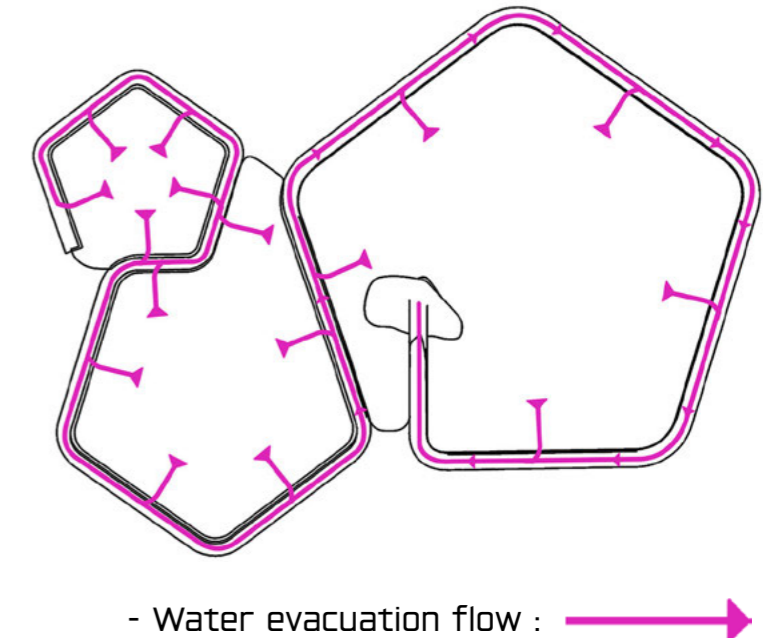
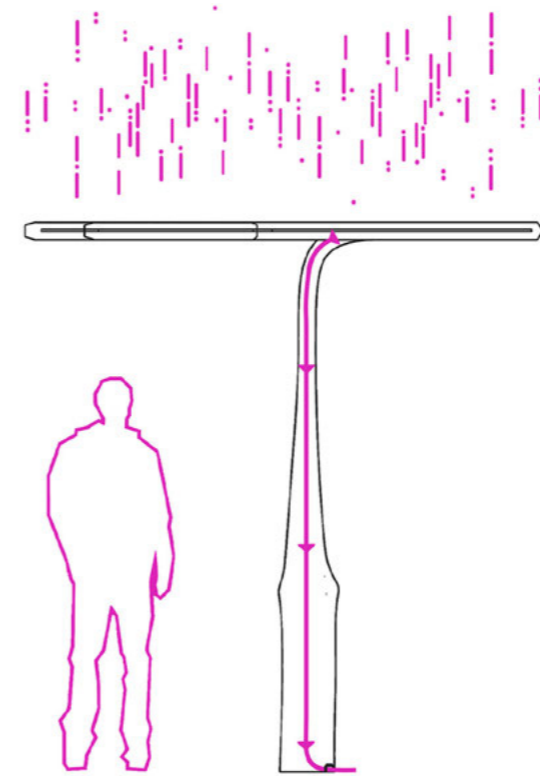

- Water evacuation flow : 

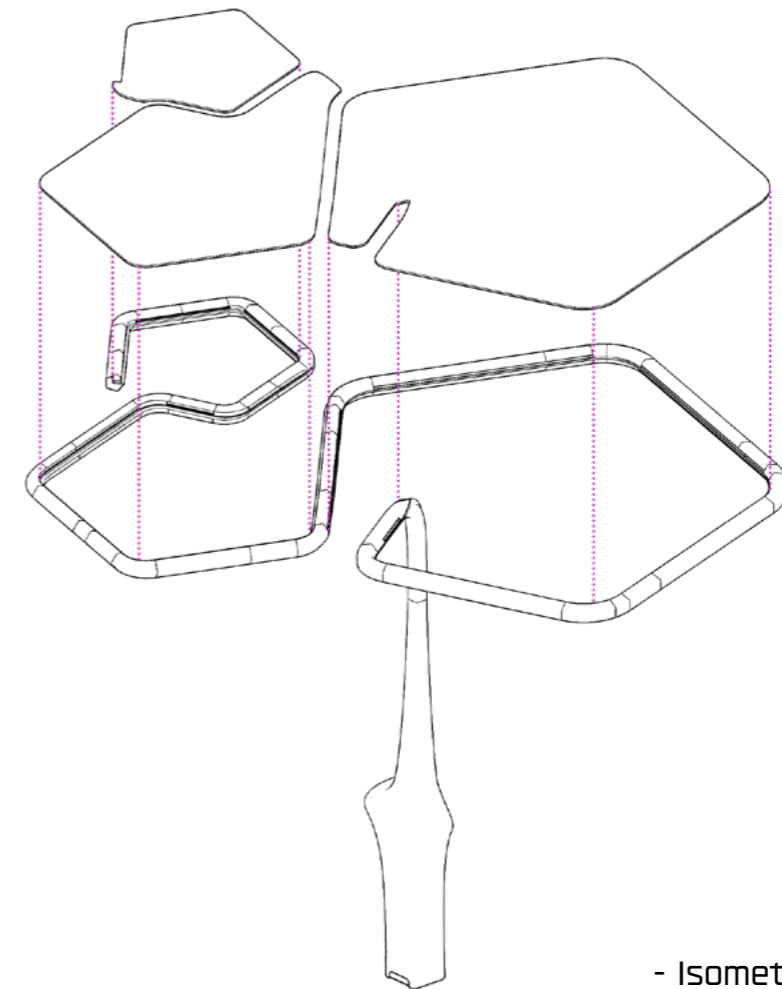

- Isometric view of one module

Calcestruzzo - 2024

Architecture - Villa Medici's bedrooms renovation

Calcestruzzo - Italian word for concrete - is a project that aims to explore minimalism and brutalism in the context of an Italian Renaissance Palazzo : the Medici villa. The combination of wood and concrete and the use of terrazzo (a very ancient Italian technique) allow the conjugation of Modern elegance with the strictness of the Cinquecento.



- Living room and bedroom



- Living room and kitchen details

- Bathroom detail



Calcestruzzo

Plans and sections

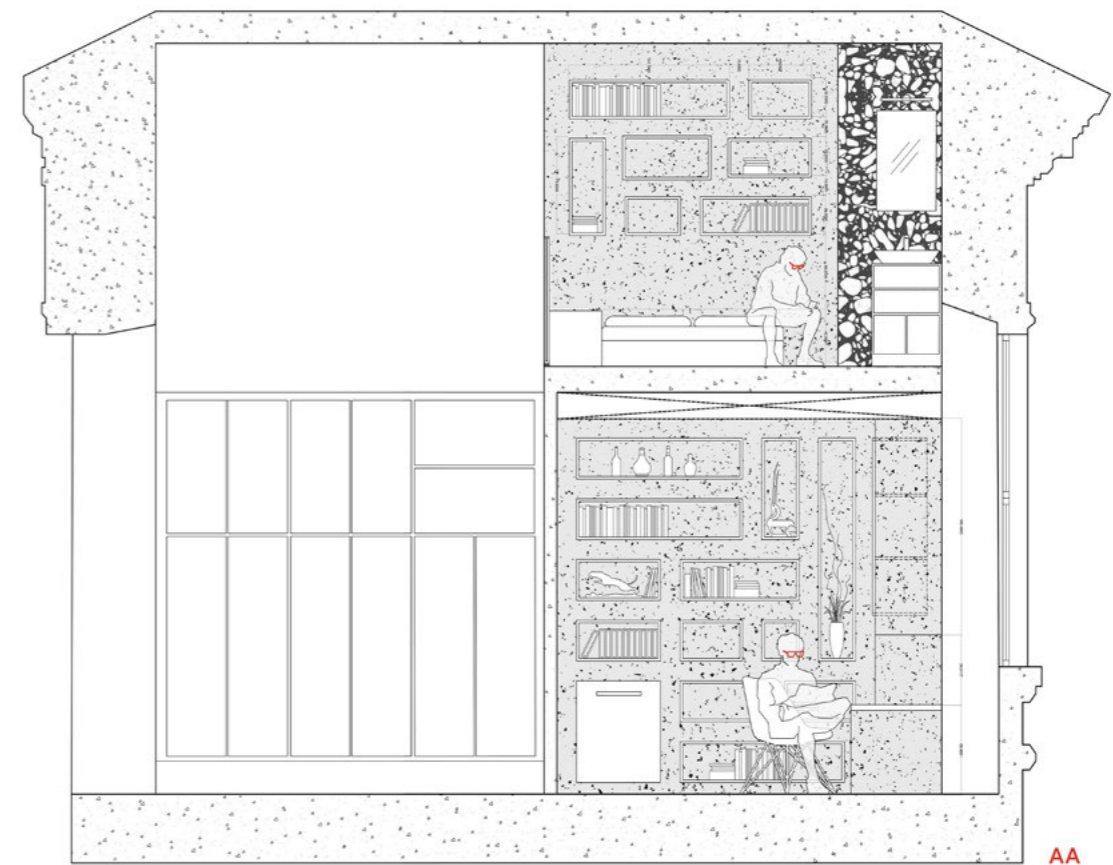
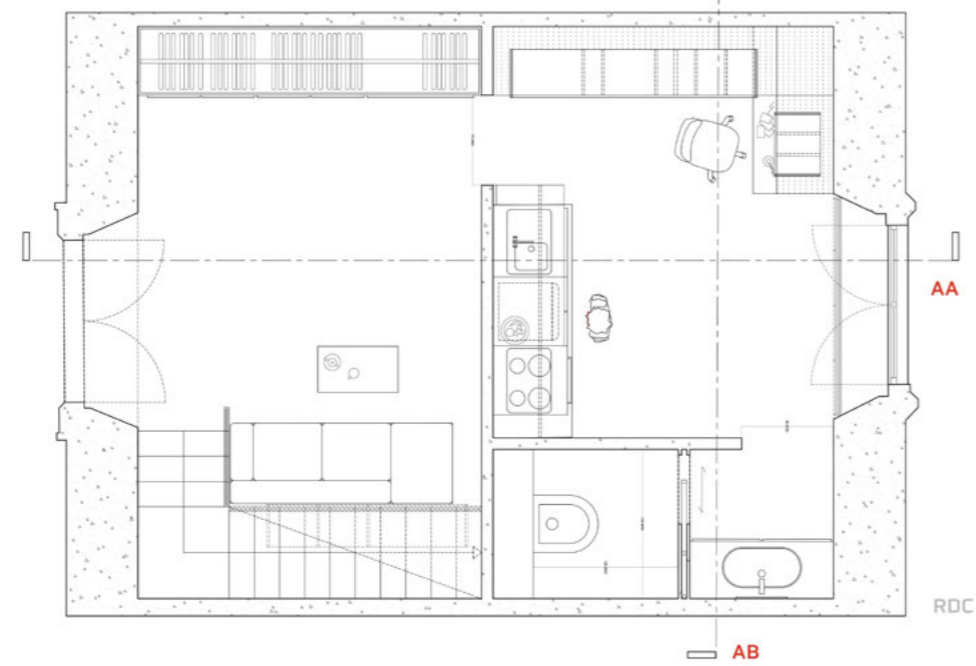
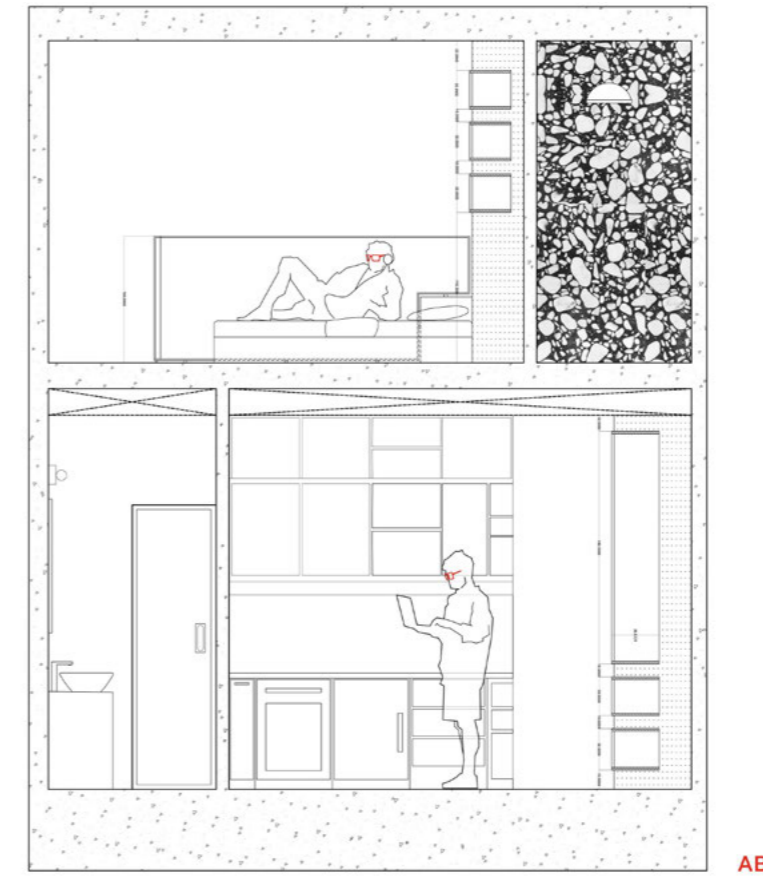
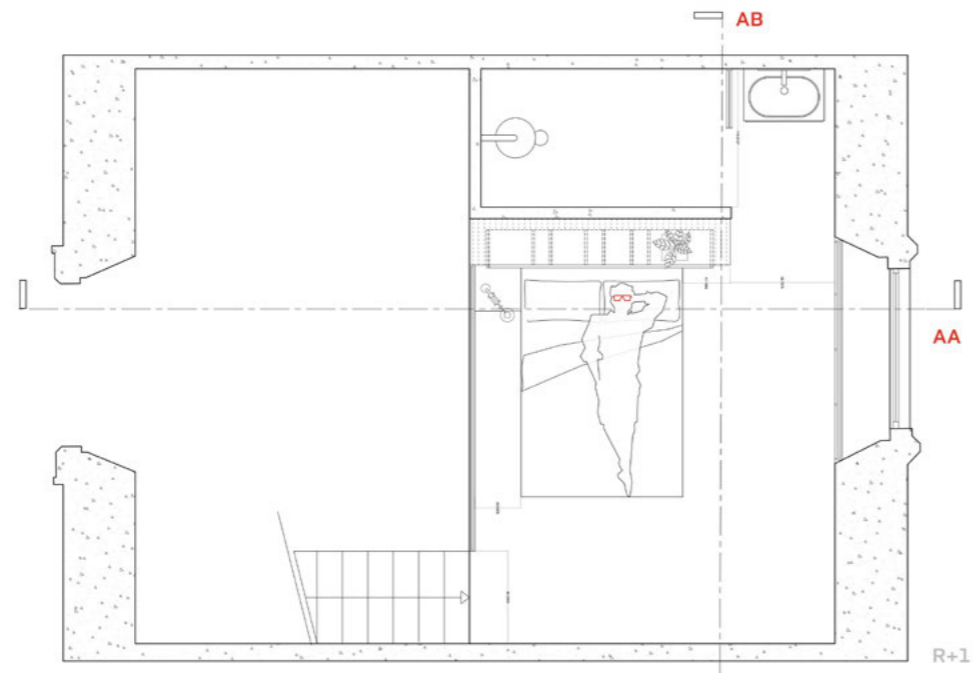
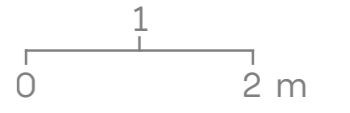

Riom168 - 2024

Architecture - Rehabilitation of a WWII prison into a youth hostel

Riom168 is a high-end youth hostel. The quality of the design is a very important factor in the context of this project in which the conservation of the original building was essential.

In Riom, the memory of the prison remains, adapting to the spaces and changing their original uses were crucial in laying out spaces where life would be comfortable.

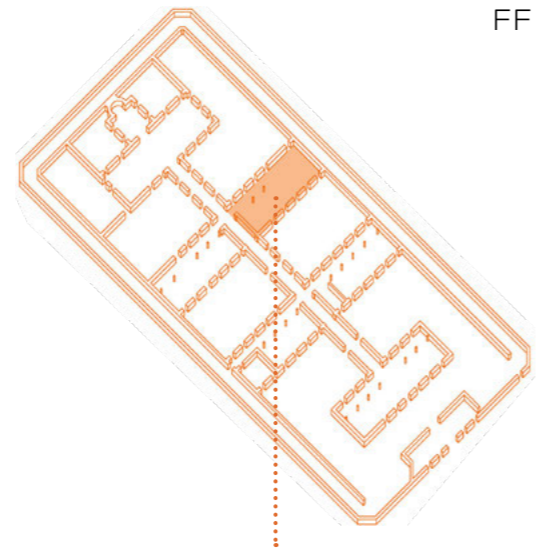

FF

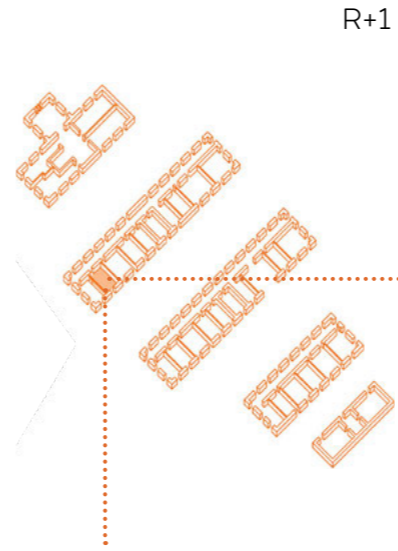

R+1

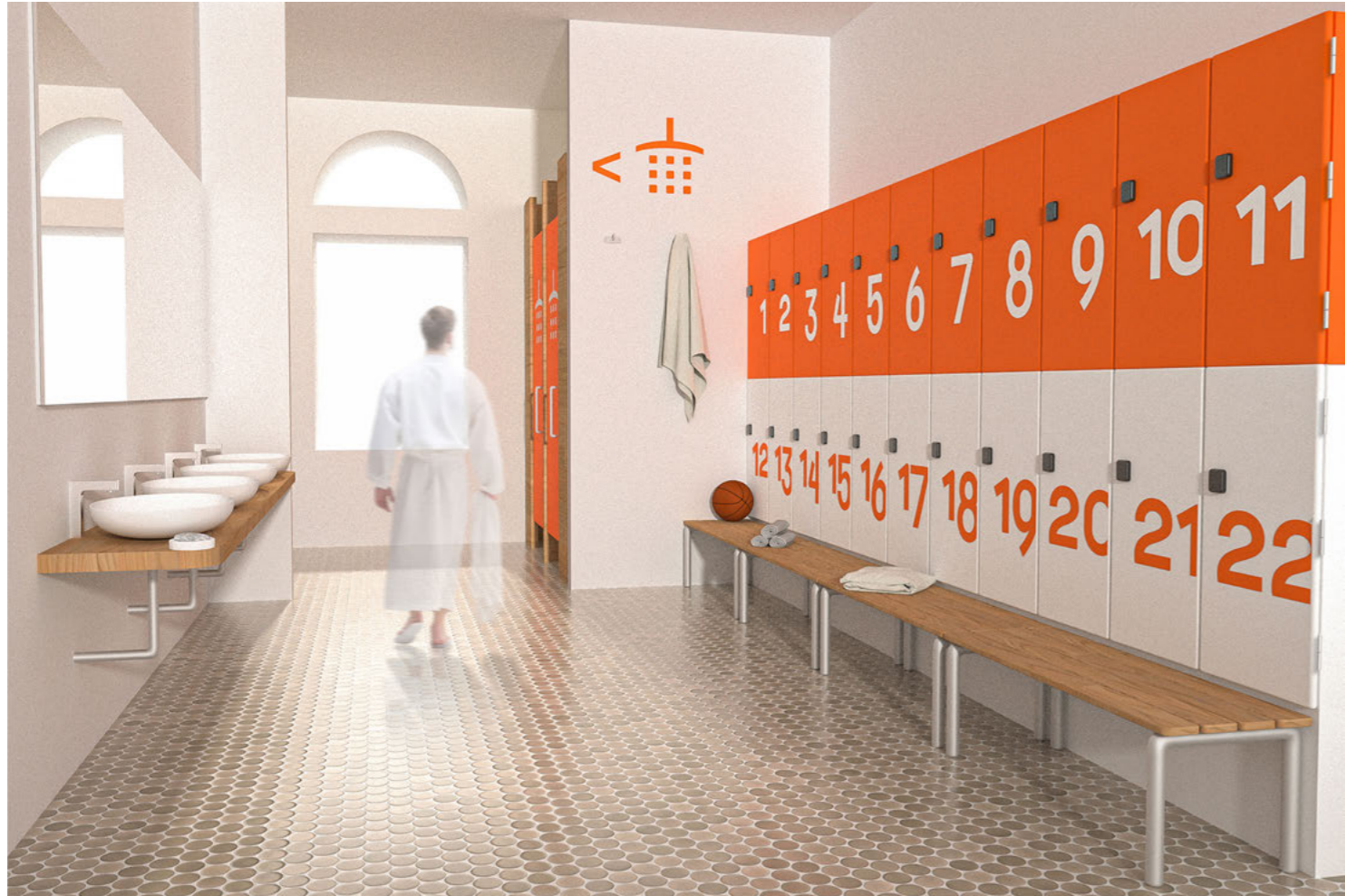

-Locker room



- Bedroom of four

Riom168

Project's visuals

R1 Bedroom

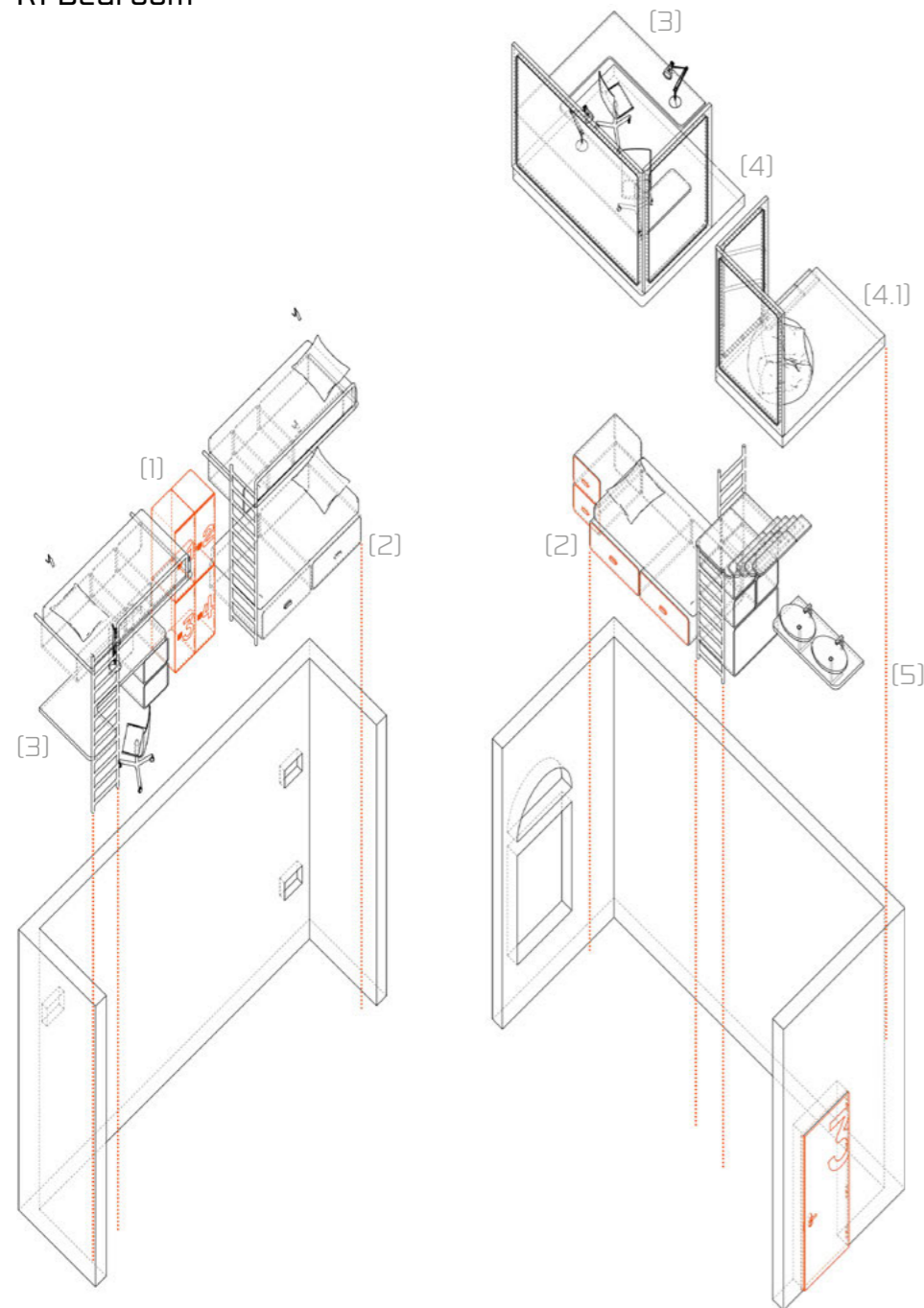

- Exploded axonometric view

FF Locker room

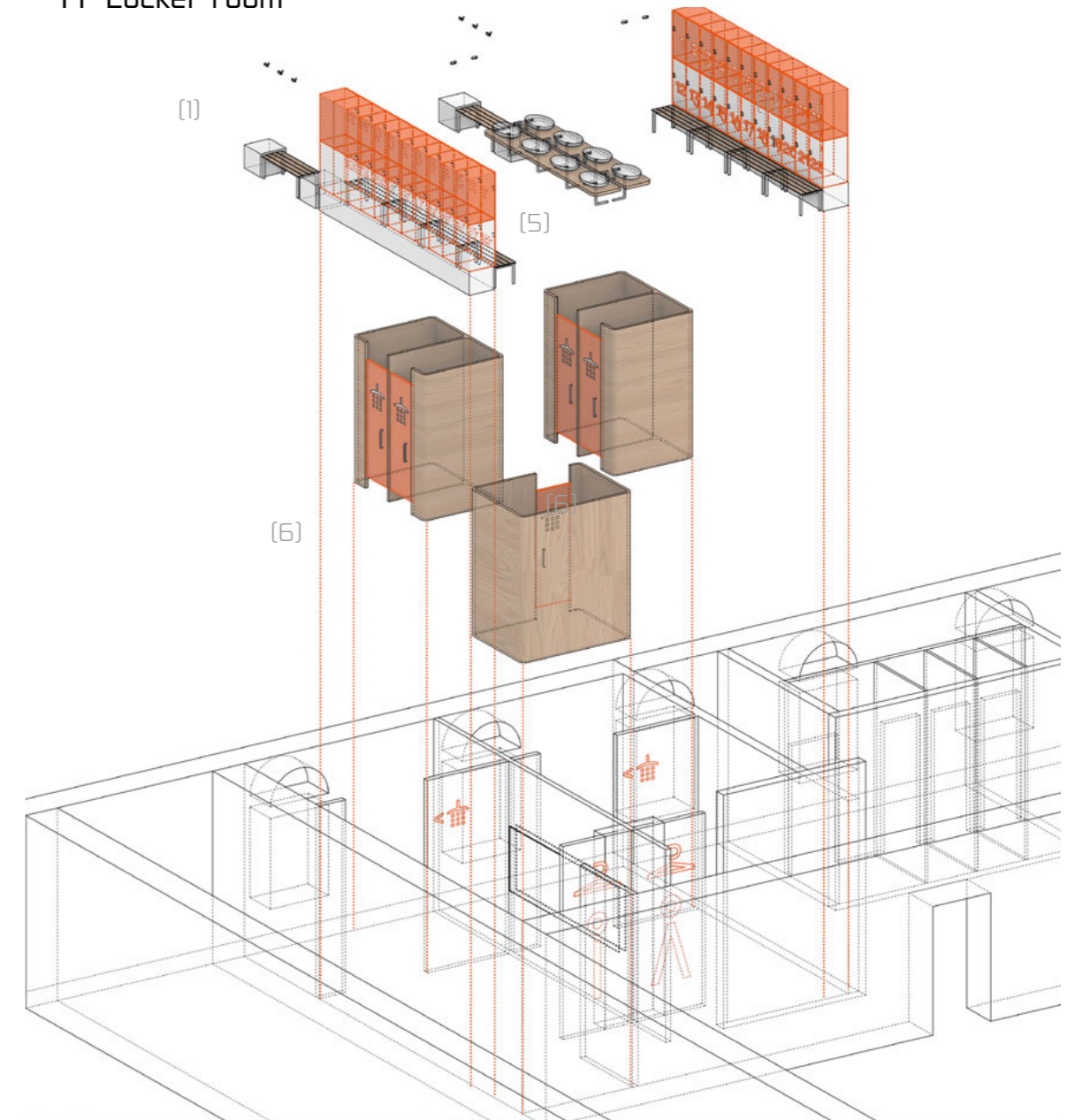

- Exploded isometric view and textures

- (1) : Lockers (code or card)
- (2) : Storage
- (3) : Office
- (4) : Mezzanine
- (4.1) : Mezzanine
- (5) : Sinks
- (6) : Showers



- Pictograms and materiality

EXO - 2024

Service and Product Design - Connected object

EXO is a service thought out to accompany people who smoke and want to follow, diminish their consumption or even stop smoking completely.

EXO is a connected object in which one inserts its pack of cigarettes.

The app generates statistics and allows the user to set long or short term goals.

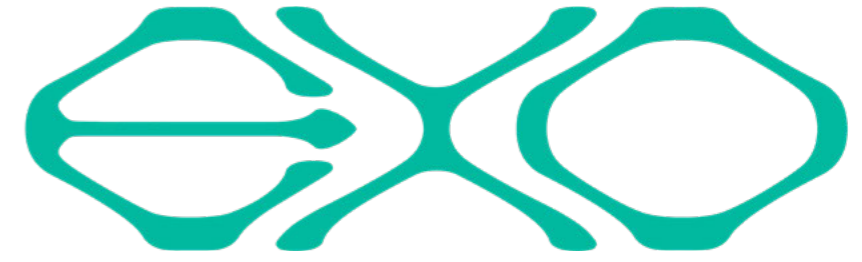

EXO

Details and technicity



1. Install app, create a user profile and order Exo.



2. After delivery, open Exo.

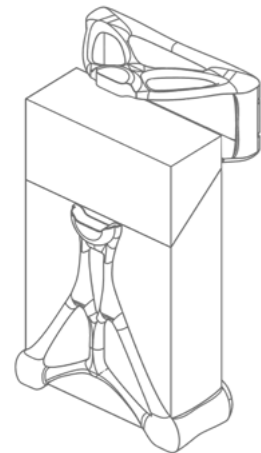

3. Insert cigarette pack.

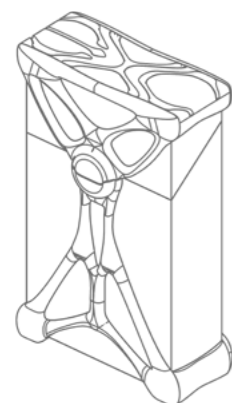

4. Depending on your set objectives, the follow-up begins and statistics are created.

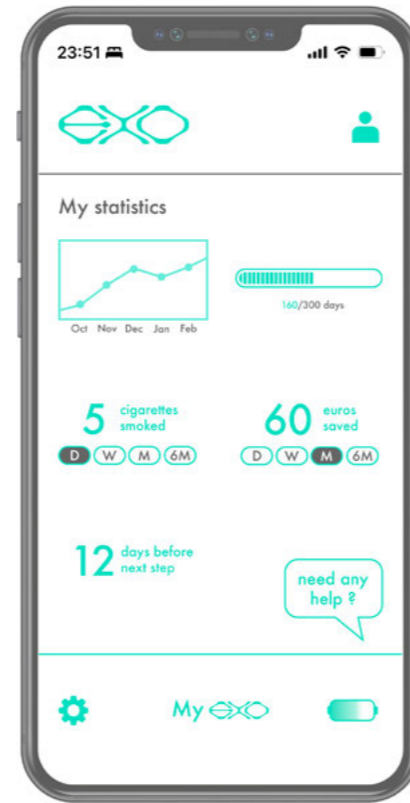

App pages examples

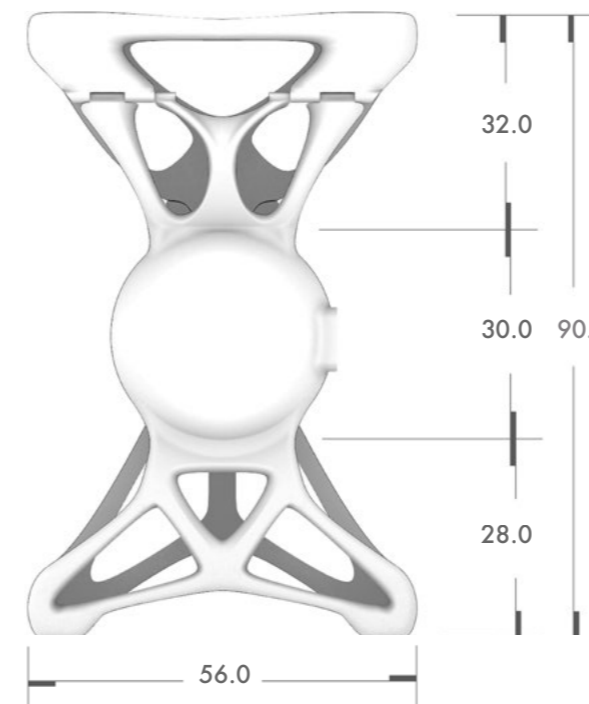
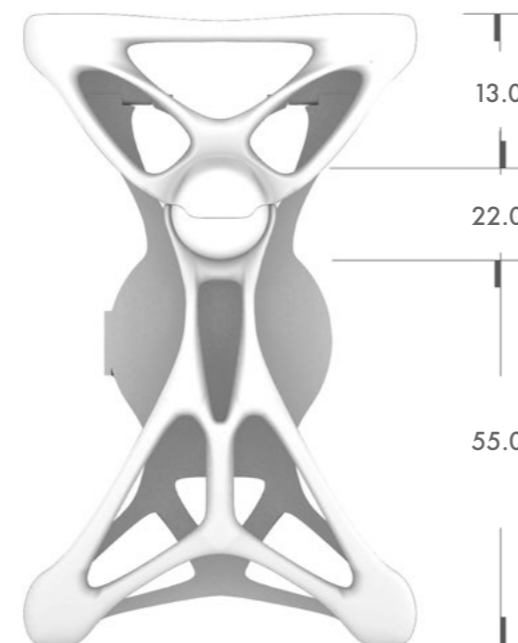

Technical plans

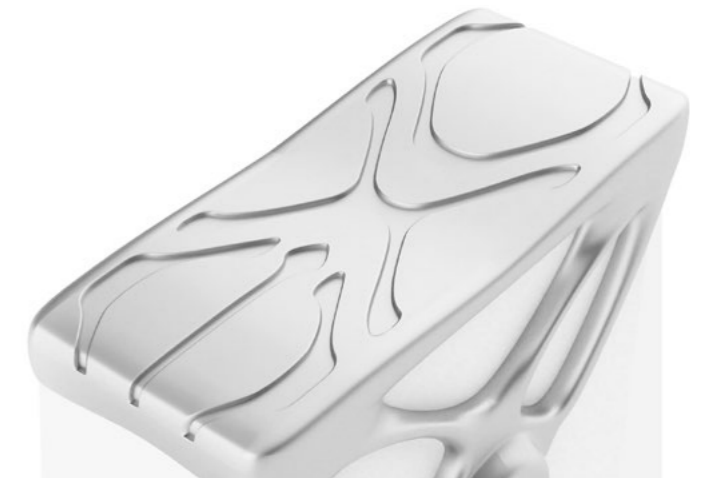

Engraved logo



USB-C port, rechargeable battery

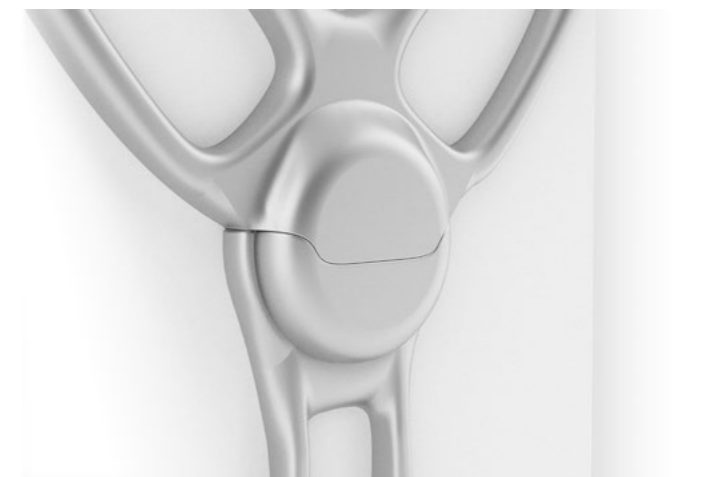

App managed locking system

EXO

Researches and sketching

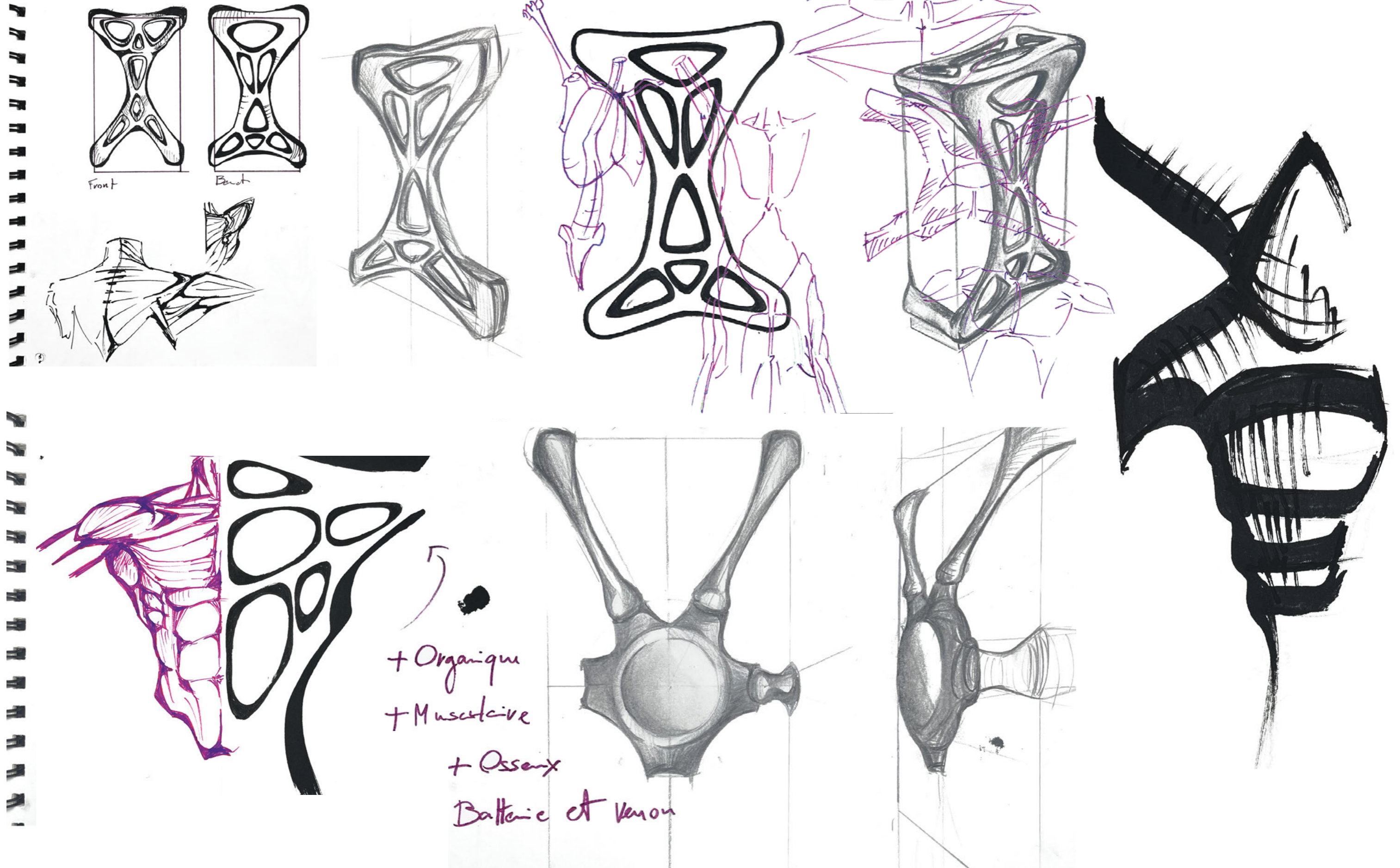

IceBerg - 2022

Product design - Vodka bottle

IceBerg is a bottle of vodka created as a concept for the Verralia Design awards contest. The iceberg is a symbol of natura beauty. These asymetrical ice mountains, peacefully gigantic are without a doubt some of the most impressive natural structures. The IceBerg vodka bottle is directly inspired by them.



IceBerg

Usage value

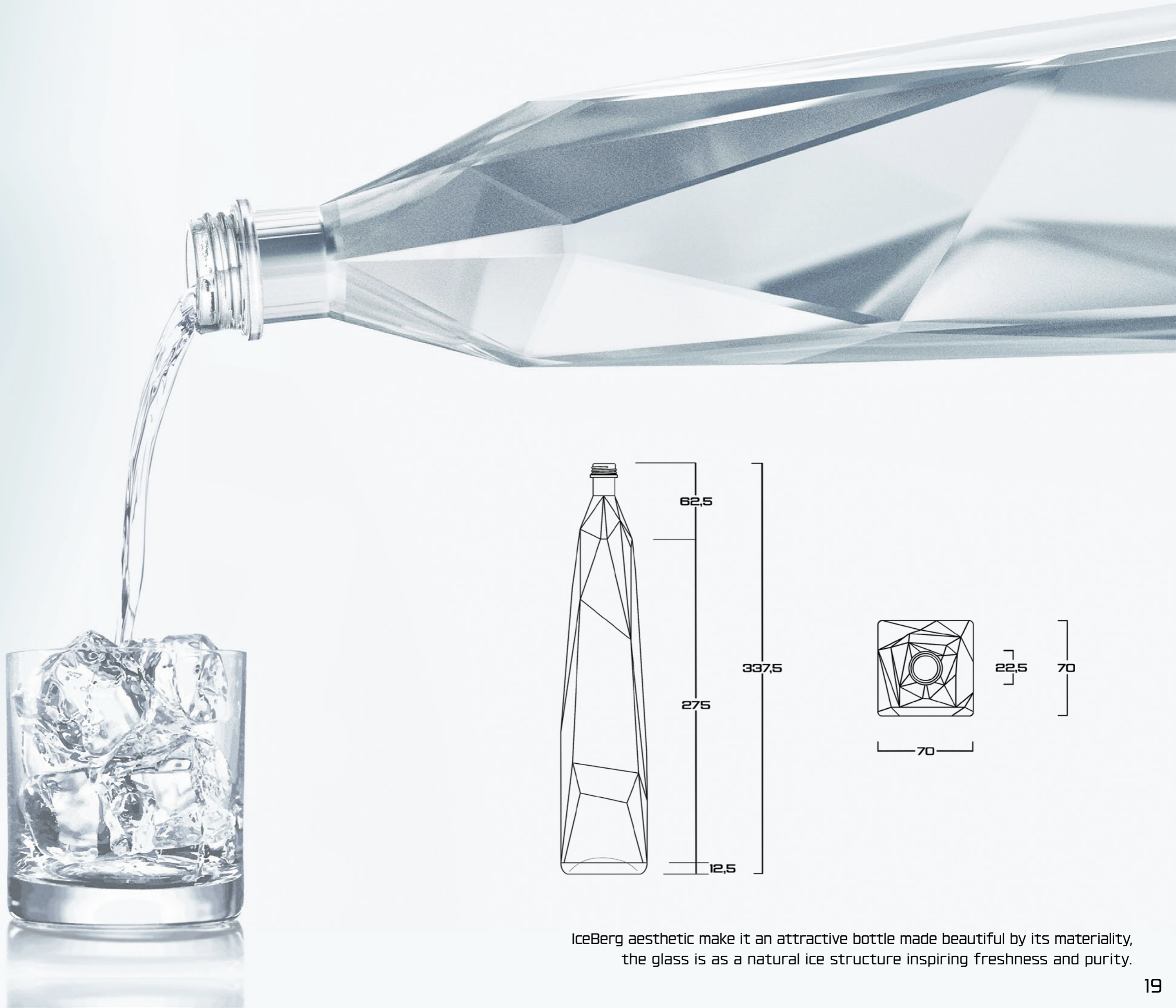

IceBerg aesthetic make it an attractive bottle made beautiful by its materiality, the glass is as a natural ice structure inspiring freshness and purity.

Trip to Mars - 2023

Product design - Toy

Trip to Mars is a toy that aims to develop the children's imagination. The user is free to create its own stories with a kit designed to offer him a maximum of creative possibilities. The different elements are made of birch wood, a material chosen for its sustainability and durability but also to show that "Trip to Mars" is not an object that is made to be discarded, it's an transgenerational token that should be transmitted.

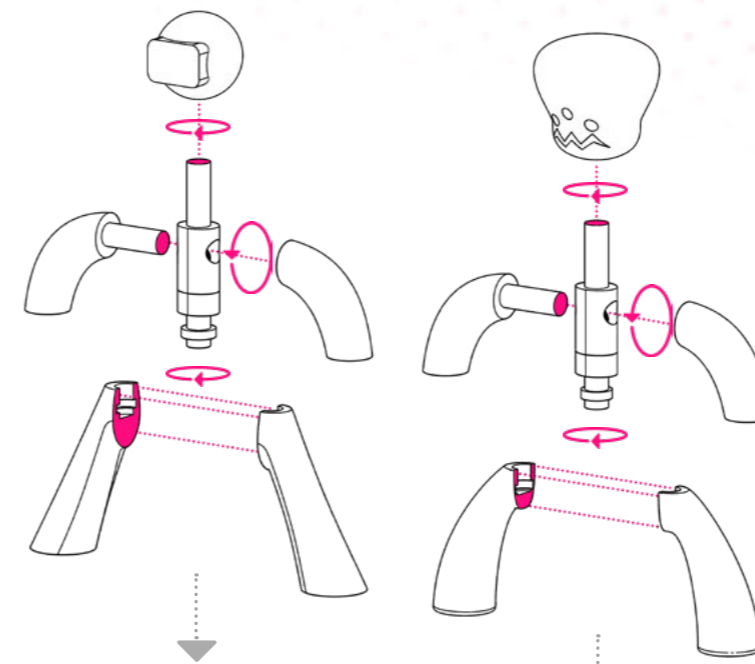

- Assembly diagram

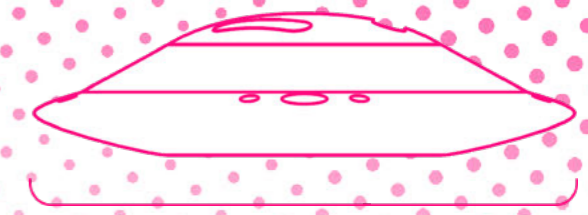

∅ 215 mm

Saucer

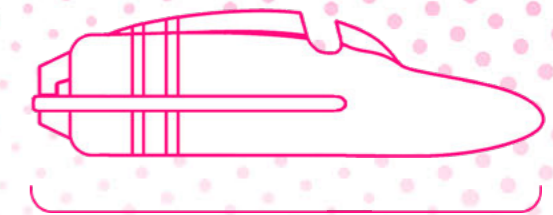

220 mm

Ship

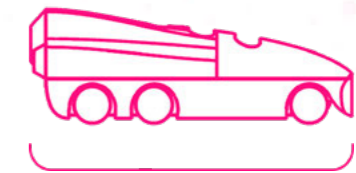

140 mm

Rover

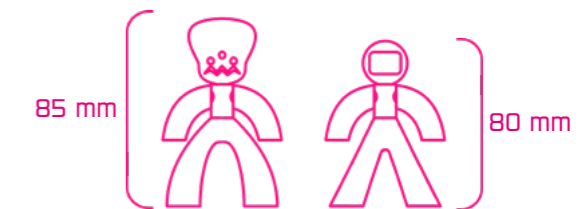

85 mm

80 mm

Martian and astronaut

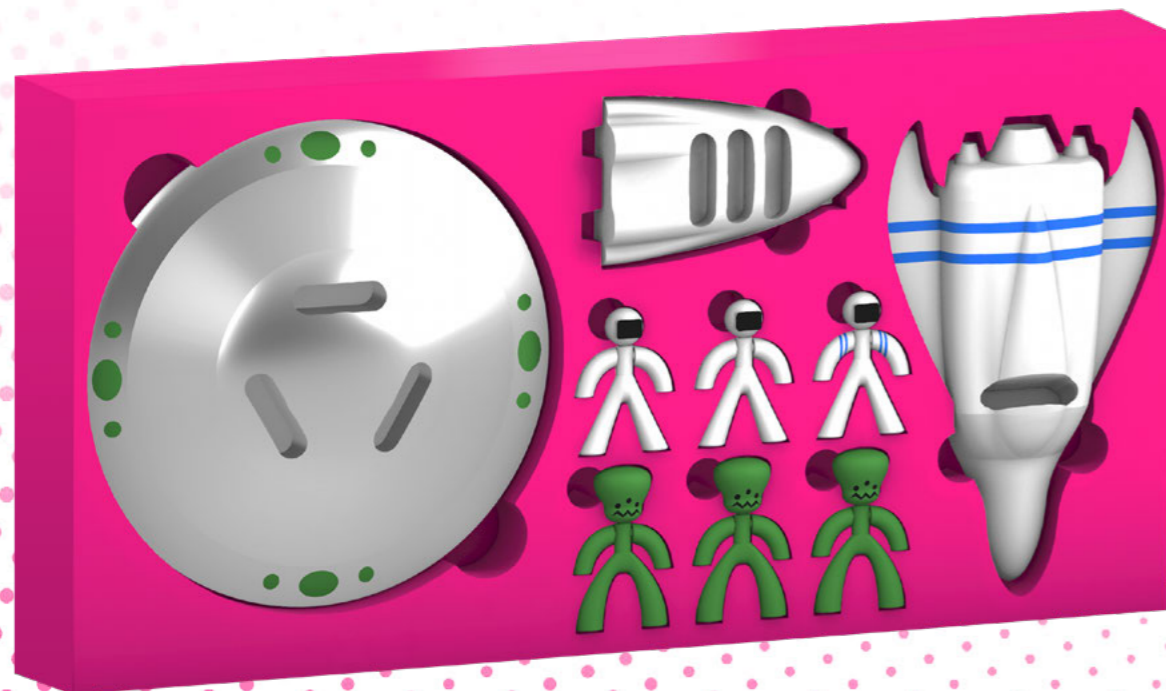
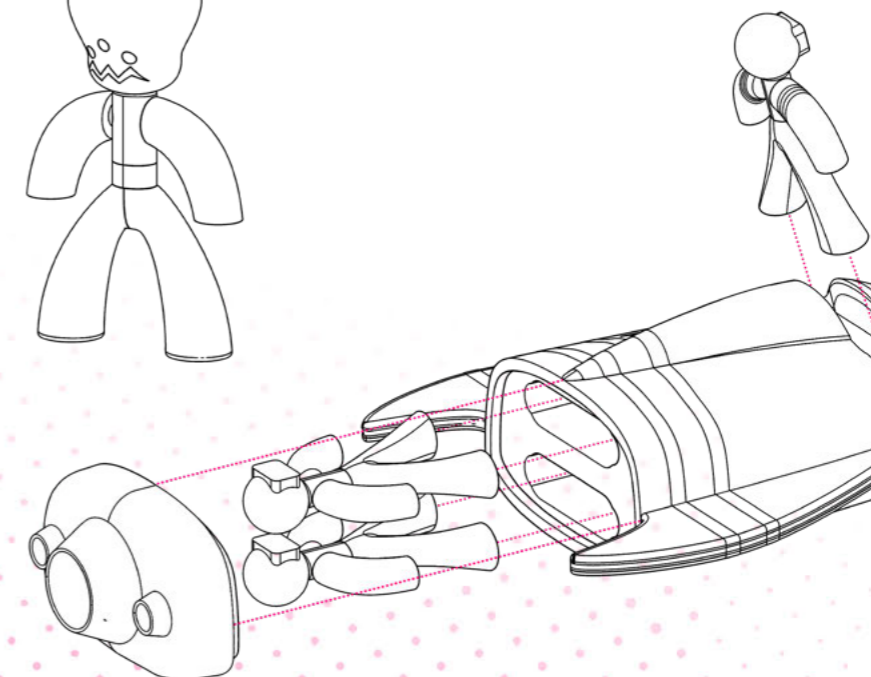

Selva - 2023

Architecture - Brazilian villa

Selva is a concept villa located in Manaus, Amazonas, Brasil. Manaus is the biggest city of the Amazonian forest. The climate there is tropical meaning it is hot and damp all year round. In this shared accommodation live two couples. Manaus is a true entry way toward the Brazilian jungle hence the name "Selva", Portuguese for "jungle".

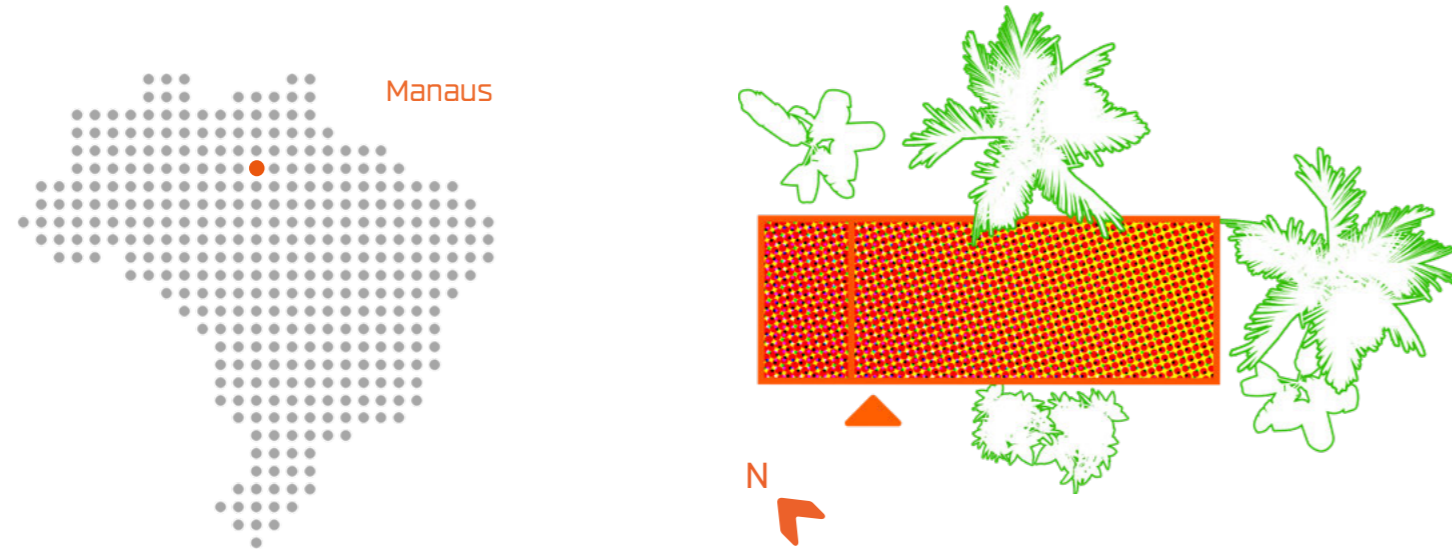

-Living room and library

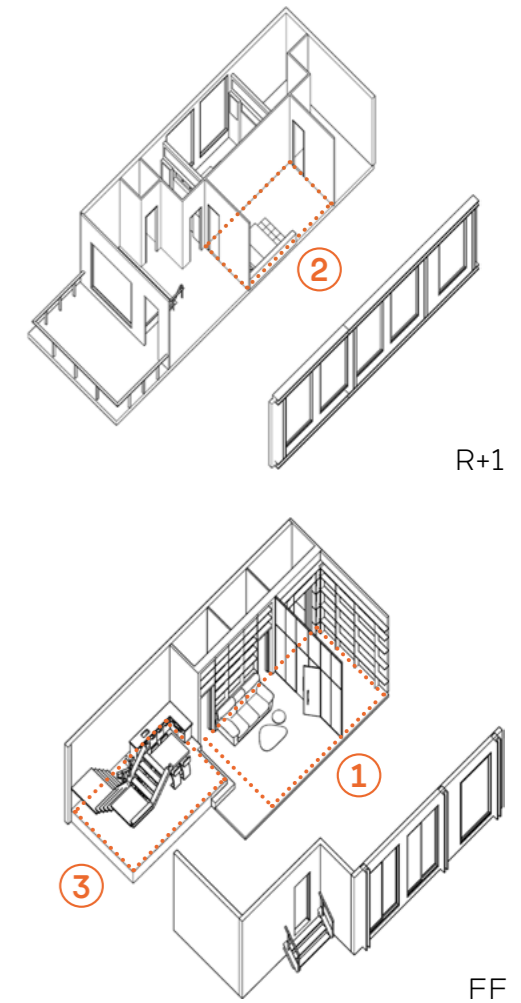

- Upstairs bedroom



- Kitchen and dining room